

TECHNICAL ADVICE DOCUMENT

Severe winter conditions

1. This Technical Advice Document applies when:

- Air temperature is below 3°C and loading conditions are exposed to frost, ice and snow.



The advice covers the following products:

- Sections loads, including mixed product 'fabricator' loads
- Rail
- Plates
- Rod/bar in coil
- Bar
- Special profiles
- Pipe
- Semi-finished products (blooms, billets, slabs, ingots).

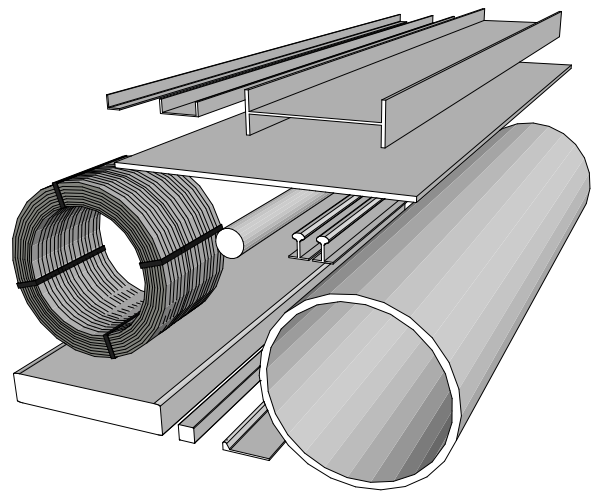

2. Essential requirements

- Trailers must be clear of snow.
- All restraint equipment must be inspected before use and be in good condition - see relevant Technical Information Sheets for Timber Dunnage, Webbing Straps, Transport Chains and Edge Protection.
- All webbing straps must have a minimum lashing capacity of 2000daN, and must be compliant with EN 12195-2.
- Edge protection must be applied to webbing straps at all sharp or abrasive edges, including trailer chassis frame and side rails.
- All chains must be 8mm, Grade 8 with a lashing capacity of 4 tonnes and be compliant with EN 12195-3.

3. Winter alert levels

Amber alert - less than 3°C



- ✓ Use dry timbers

OR

- ✓ Apply additional restraints - see overleaf.

Red alert - less than 0°C

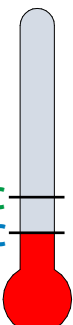

- ✓ Use dry timbers where possible

AND

- ✓ Apply additional restraints - see overleaf.

Note: Testing has shown that friction coefficients can be reduced by as much as 50% in freezing conditions.

TECHNICAL ADVICE DOCUMENT

Severe winter conditions

4. Additional restraints required for freezing conditions

4.1 Sections, non-banded including mixed product 'fabricator' loads

4.1.1 Chains

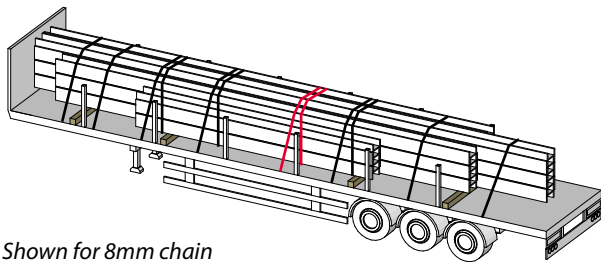

Shown for 8mm chain

Note: Banded sections loads should move to a minimum of 3 belly-wrapped and 3 over-the-top chains.

- ✓ Use dry timbers where possible.
- ✓ Follow Load Restraint Guideline LRG-0002-SS for load configuration requirements.
- ✓ Add 1 belly-wrapped chain to standard restraint system.
- ✓ Full load requires one of the following options:
 - 8mm chains - 4 belly-wrapped and 4 over-the-top.
 - 10mm chains - 3 belly-wrapped and 3 over-the-top.
- ✓ Side pins fitted.

4.1.2 Webbing straps

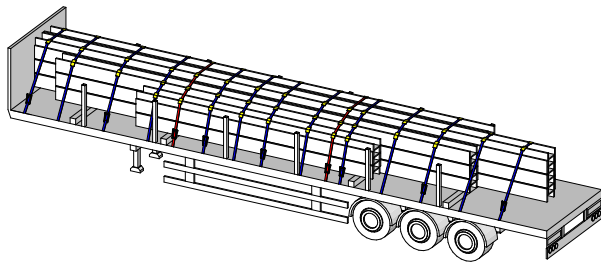

Shown for LC 2000 daN straps

- ✓ Use dry timbers where possible.
- ✓ Follow Load Restraint Guideline LRG-0003-SS for load configuration requirements.
- ✓ Add 2 over-the-top straps to standard restraint system.
- ✓ Full load requires one of the following options:
 - LC 2000daN straps - 15 over-the-top.
 - LC 2500daN straps - 13 over-the-top.
- ✓ Side pins fitted.

4.2 Rail

Option 1

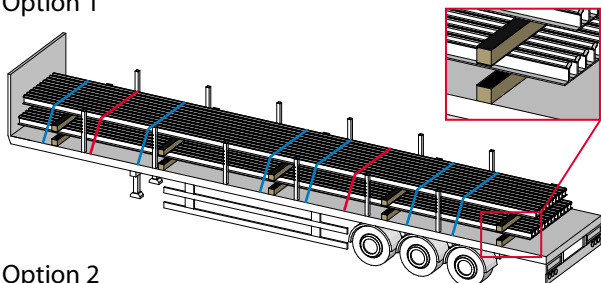

- ✓ Use dry timbers.
- ✓ Load to the headboard.
- ✓ Fit side pins.

Option 1

- ✓ Add anti-slip matting and 2 over-the-top straps.
- ✓ Full load requires anti-slip matting between all rail and timber surfaces and 8 over-the-top straps.

Option 2

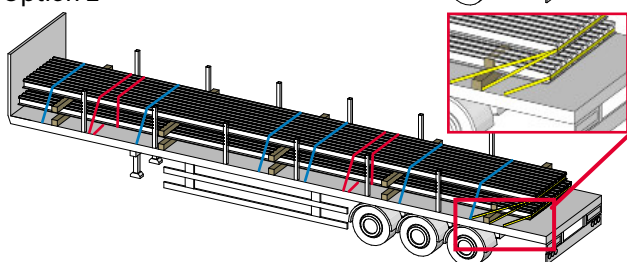

Option 2

- ✓ Add 2 pairs of opposing loops and 3 straps at rear.
- ✓ Full load requires 6 over-the-top straps, 2 pairs of opposing loops and 3 direct restraints at rear of load, as depicted.

Shown for LC 2000 daN straps

TECHNICAL ADVICE DOCUMENT

Severe winter conditions

4.3 Plate

4.3.1 Narrower than trailer

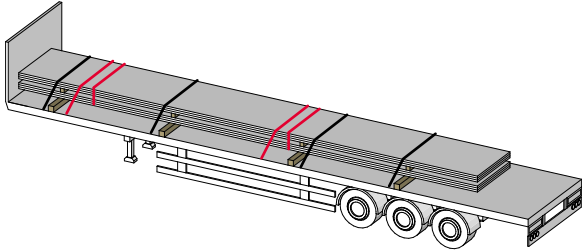

Shown for 8mm chain with webbing tensioners

- ✓ Use dry timbers where possible.
- ✓ Load to the headboard where possible.
- ✓ **Add a minimum of 2 belly-wrapped chains.**
- ✓ Full load requires one of the following options:
 - 3 over-the-top chains with bottle tensioners + 2 belly-wrapped chains.
 - 4 over-the-top chains with webbing tensioners + 2 belly-wrapped chains.
 - 6 over-the-top straps + 3 belly-wrapped straps.

4.3.2 Wide plate

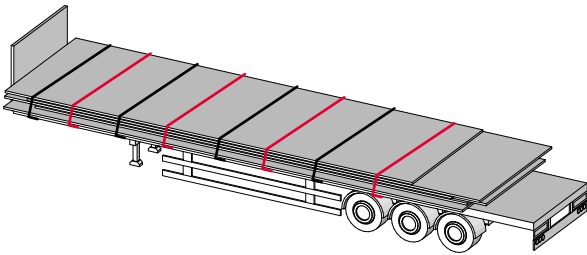

Shown for 8mm chain with webbing tensioners

- ✓ Use dry timbers where possible.
- ✓ Load to the headboard where possible.
- ✓ **Double the normal restraints used.**
- ✓ Full load requires one of the following options:
 - 6 over-the-top chains with bottle tensioners.
 - 8 over-the-top chains with webbing tensioners.
 - 12 over-the-top straps.

4.3.3 Mixed length loads

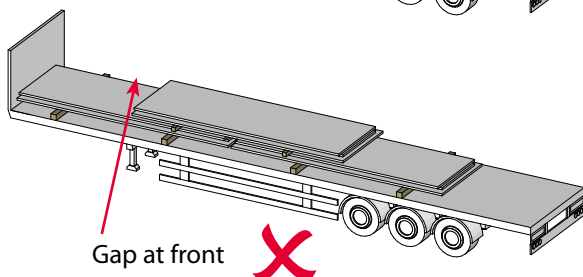
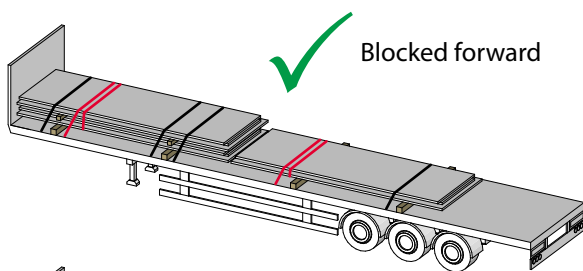

Shown for narrow plate using 8mm chain with webbing tensioners

- ✓ Use dry timbers where possible.
- ✓ Load front plates to the headboard and butt rear plates to them.
- ✓ For narrow plate **add 2 belly-wraps** as per Section 4.3.1.
- ✓ For wide plate **double the normal restraints** as per Section 4.3.2.

TECHNICAL ADVICE DOCUMENT

Severe winter conditions

4.4 Rod/bar in coil - gunbarrel

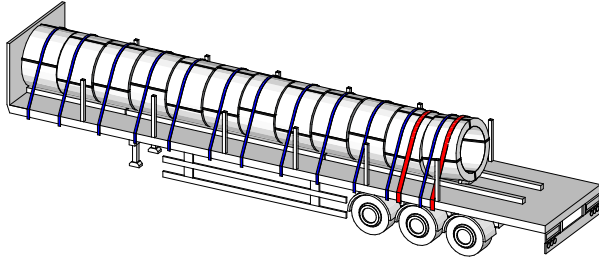

- ✓ Loaded against headboard or A-frame; on timber chocks minimum 100 x 100 square section; each coil restrained with an over-the-top strap.
- ✓ 2 additional over-the-top straps applied at the rear of the load.

Note: The same principle applies to rod in coil loaded across the trailer and blocked at the rear with a pair of gunbarrel coils, i.e. the rear coils require 2 additional straps.

4.5 Black bar

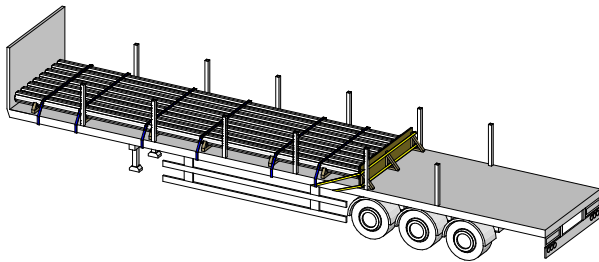

- ✓ Use dry timbers where possible.
- ✓ Timbers should have side chocks fitted.
- ✓ Load against headboard or block forward.
- ✓ Block rearward.

Alternatively:

- ✓ Use anti-slip matting between bars and timbers.
- ✓ Side pins fitted.

Note: Bright Bar should be blocked forward and rearward, and chocked sideways as per current practice.

4.6 Special profiles

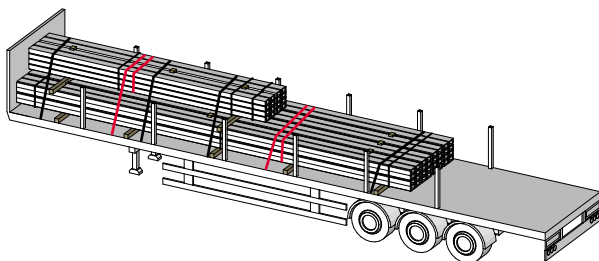

- ✓ Use dry timbers where possible.
- ✓ Load against headboard where possible.
- ✓ 2 additional belly-wrapped chains fitted above normal restraint system.

Note: If product cannot be loaded against headboard, add an additional belly-wrap restraint.

TECHNICAL ADVICE DOCUMENT

Severe winter conditions

4.7 Pipe

4.7.1 Timbered loads

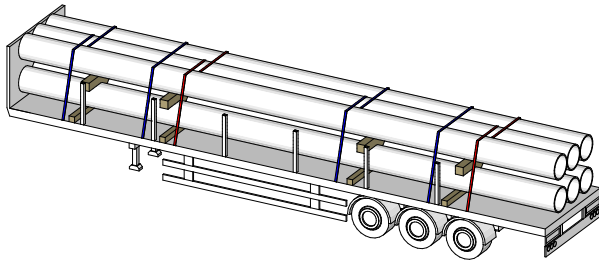

- ✓ Use dry timbers where possible.
- ✓ 2 additional belly-wraps fitted.

4.7.2 Nested loads

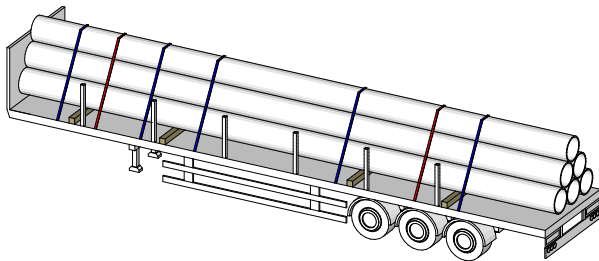

- ✓ Use dry base timbers where possible.
- ✓ 2 additional restraints fitted.

4.8 Semi-finished product (blooms, billets, slabs, ingots)

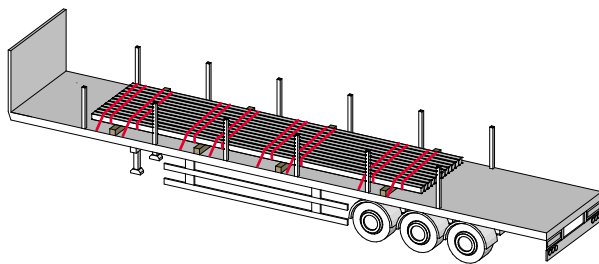

Shown for LC 2000 daN straps

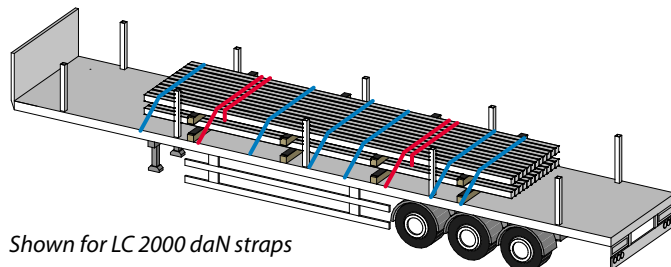

Shown for LC 2000 daN straps

Option 1

- ✓ Use dry timbers where possible.
- ✓ All belly-wrapped restraints fitted.
- ✓ Full load requires one of the following options:
 - Chains - 5 belly-wrapped.
 - Straps - 8 belly-wrapped.
- ✓ Side pins fitted where possible.

Option 2

- ✓ Use anti-slip matting between timbers and product.
- ✓ Full load requires one of the following options:
 - Chains - 2 belly-wrapped and 4 over-the-top.
 - Straps - 2 belly-wrapped and 6 over-the-top.
- ✓ Side pins fitted where possible.

Care has been taken to ensure that this information is accurate, but Tata Steel Europe Limited and its subsidiaries do not accept responsibility or liability for errors or information that is found to be misleading.